



cellQART® Cell Culture Inserts

Pre-loaded in especially designed Well Plates or as Single Inserts





SABEU – Plastics & Membrane Technology

We are a leading system provider of microporous filter membranes and injection molded components. In these areas we develop products based on customer specifications, manufacture serial products and set own standards with our cellQART®, TRAKETCH® and FLUXX® product lines – all Made in Germany.

cellQART® – Cell Culture Inserts

With our cellQART® Cell Culture Inserts we are committed to the 3Rs principle of reducing, refining and replacing animal testing while advancing human benefit. Further, we are dedicated to resolve the dilemma of customer needs for innovative cell culture products meeting highest standards at affordable prices. This product portfolio come with PET membranes in translucent, clear extended culture or clear optics in 6-, 12- and 24-Well format. The Inserts are tissue culture treated, sterile and are compatible with most standard Cell Culture Plates.

Additionally cellQART® Cell Culture Inserts are available with our especially designed Well Plates. These Well Plates are supplied in 6-, 12 and 24-Well format, are sterile and pre-loaded with cellQART® Cell Culture Inserts.

Table of content

Product benefits..... 3
 Product design..... 4-5
 Product characteristics..... 6
 Applications 7
 Portfolio overview 8-9
 Innovative products..... 10-11



Make superior Cell Culture Inserts affordable

In many cases, high quality cell culture inserts might not always be manufactured directly by the brand you buy from and are available at unnecessary high prices. As the true OEM since 1958, we control a lean supply chain to the end user and deliver value by focusing on our core competences: plastics & membrane technology.

With this saving opportunity in your lab operations budget we further aim to:

Support users putting insights into innovative Cell Culture Products

With a proven track record of collaborative product development in the fields of cell culture, rapid microbiology, oncology testing and medical devices we are eager to bring our customers ideas to life. Our R&D project management organization is prepared to co-develop products designed around your needs.

Notice
 Please visit our website (www.cellQART.com) for the latest and most up-to-date information. The information provided in this document herein is subject to change at any time without notification. This document does not commit SABEU in any way. SABEU is not responsible for any errors that may appear in this document.

Product benefits



Your benefits using cellQART® Cell Culture Inserts pre-loaded in Well Plates:

- Stable positioning of the Inserts within the wells
- Simplified pipetting by reduction of handling efforts
- Optimized gas exchange by product design (lid with distance holders, Inserts with lowered top edge and embossed spots on arms)
- Reduction of unwanted mechanical forces on cells caused by insert shifting
- The design facilitates TEER electrode positioning
- Prevention of unwanted insert movement during transportation
- Lid with condensation rings to prevent from cross-contamination

Your benefits using Single cellQART® Cell Culture Inserts:

- Comfortable pipette access
- Optimized gas exchange by product design
- Compatible with most standard Cell Culture Plates
- Tissue culture treated

Your benefits using Single cellQART® Cell Culture Inserts (Flat):

- Flat Inserts allow a larger volume of culture media in the lower compartment, reducing the frequency of exchange

Your benefits using cellQART®:

- RNase/DNase free and non-pyrogenic
- Industry’s leading quality standards to ensure 100 % membrane parameter consistency and reproducible cell culture results
- Certified in accordance with DIN EN ISO 9001 and DIN EN ISO 13485 and ISO class 8 cleanroom classification
- Project based customization possible with 100 % inhouse production of plastics & membrane components

Benefits for your cells:

- *In vivo* like conditions
- Access to nutrients or substances from the apical and basolateral side

Product design – Inserts

The unique, self-centered hanging design of cellQART® Cell Culture Inserts prevents medium wicking between the Cell Culture Insert and outer well.

The design also allows access to the lower compartment through windows in the Cell Culture Insert wall, as well as undamaged co-culturing of cells in the lower compartment.

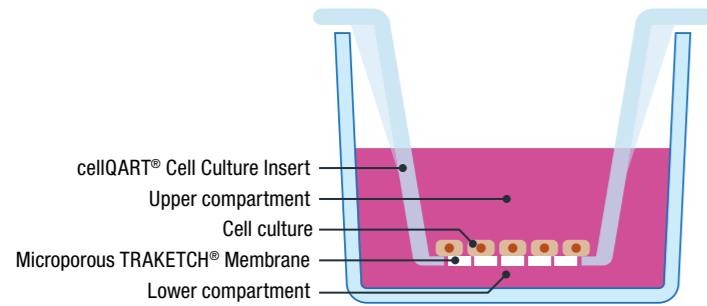

Insert dimensions

	6-Well Insert	12-Well Insert	24-Well Insert
Ø A = Inner diameter	23.9 mm	11.9 mm	6.4 mm
Ø B = Outer diameter	26.9 mm	14.9 mm	9.4 mm
† H = Height			
Regular	16.3 mm	16.3 mm	16.3 mm
Flat	n/a	n/a	11.2 mm
Growth area	4.5 cm ²	1.1 cm ²	0.3 cm ²
Working volume Insert			
Regular	1–4 ml	0.2–0.8 ml	0.1–0.4 ml
Flat	n/a	n/a	0.1–0.3 ml
Working volume Well			
Regular	2–4 ml	0.9–1.8 ml	0.6–1.5 ml
Flat	n/a	n/a	1.6–2.1 ml
Distance from Regular Insert bottom to well bottom = 1 mm			
Distance from Flat Insert bottom to well bottom = 6.1 mm			

Compatible with most standard Cell Culture Plates.

Pipette access and gas exchange

Wide window of cellQART® Cell Culture Insert for comfortable pipette access.

Asymmetric positioning of cellQART® Cell Culture Inserts...

...for comfortable pipette access to the cultivation vessel.

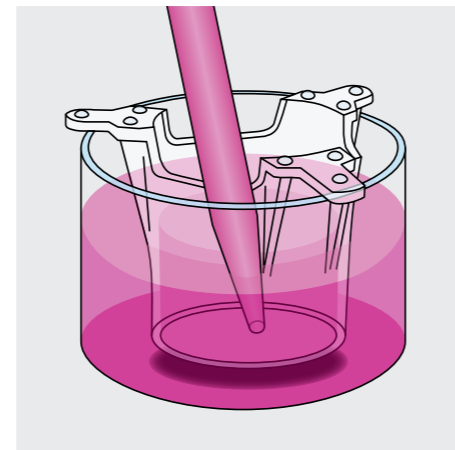
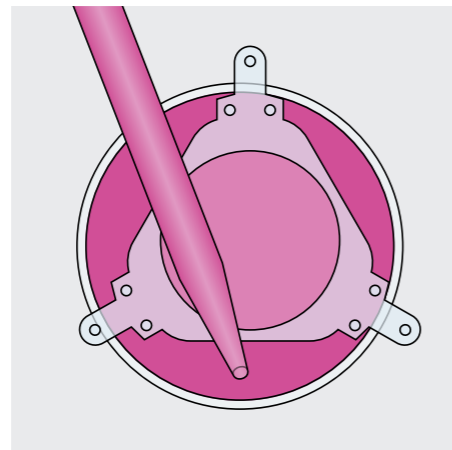
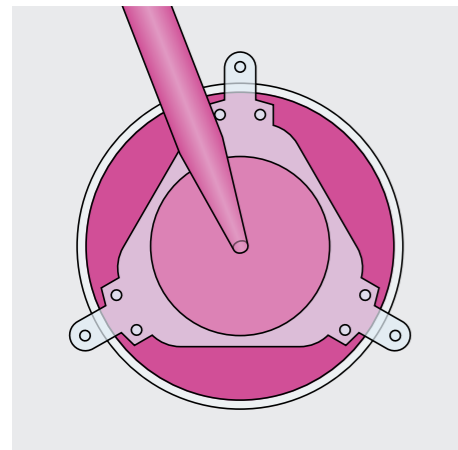

Lowered top edge for better pipette access to the cultivation vessel.

Lowered top edge and embossed spots on arms for better gas exchange.

≥ 1 mm space between cellQART® Cell Culture Inserts and bottom of cultivation vessel.

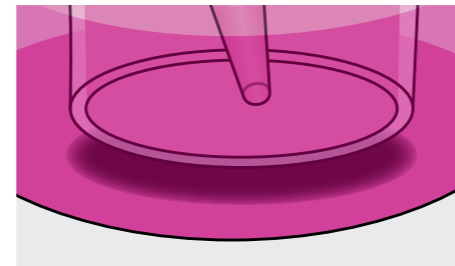
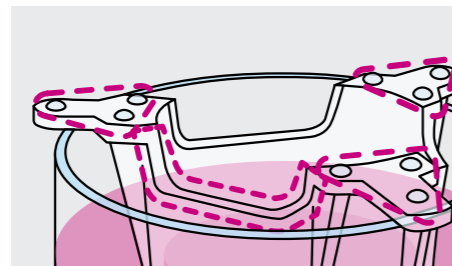
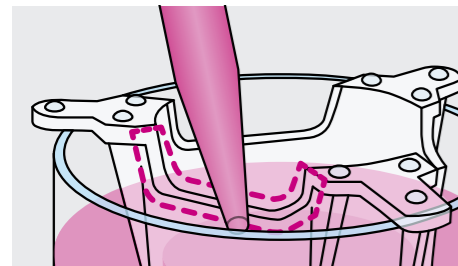

Product design – Well Plates

The especially designed Well Plates pre-loaded with cellQART® Cell Culture Inserts offer the perfect solution for cell culture and *in vitro* tissue culture research applications.

The mutually optimized design allows for stable positioning of the Inserts within the wells, reducing handling efforts and improving experimental results.

Product dimensions

	6-Well Insert	12-Well Insert	24-Well Insert
Working volume Well			
Regular	2–4 ml	0.9–1.8 ml	0.6–1.5 ml
Flat	n/a	n/a	1.6–2.1 ml
Well Plate (with lid)	23.1 x 127.76 x 85.48 mm (H x W x D)		
Distance from Insert bottom to well bottom = 1 mm			

Especially designed for cellQART® Cell Culture Inserts

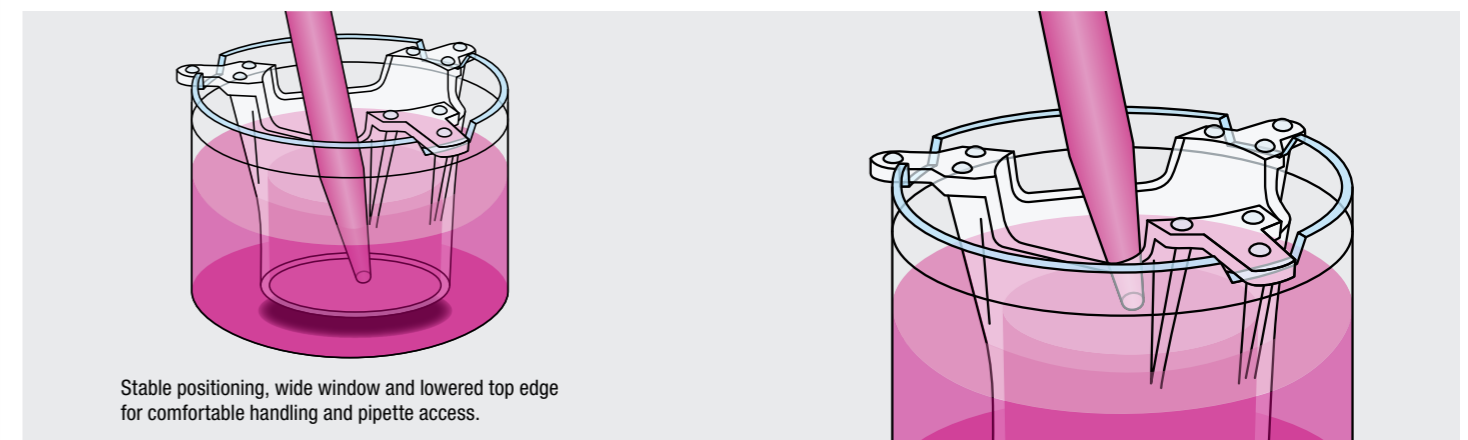
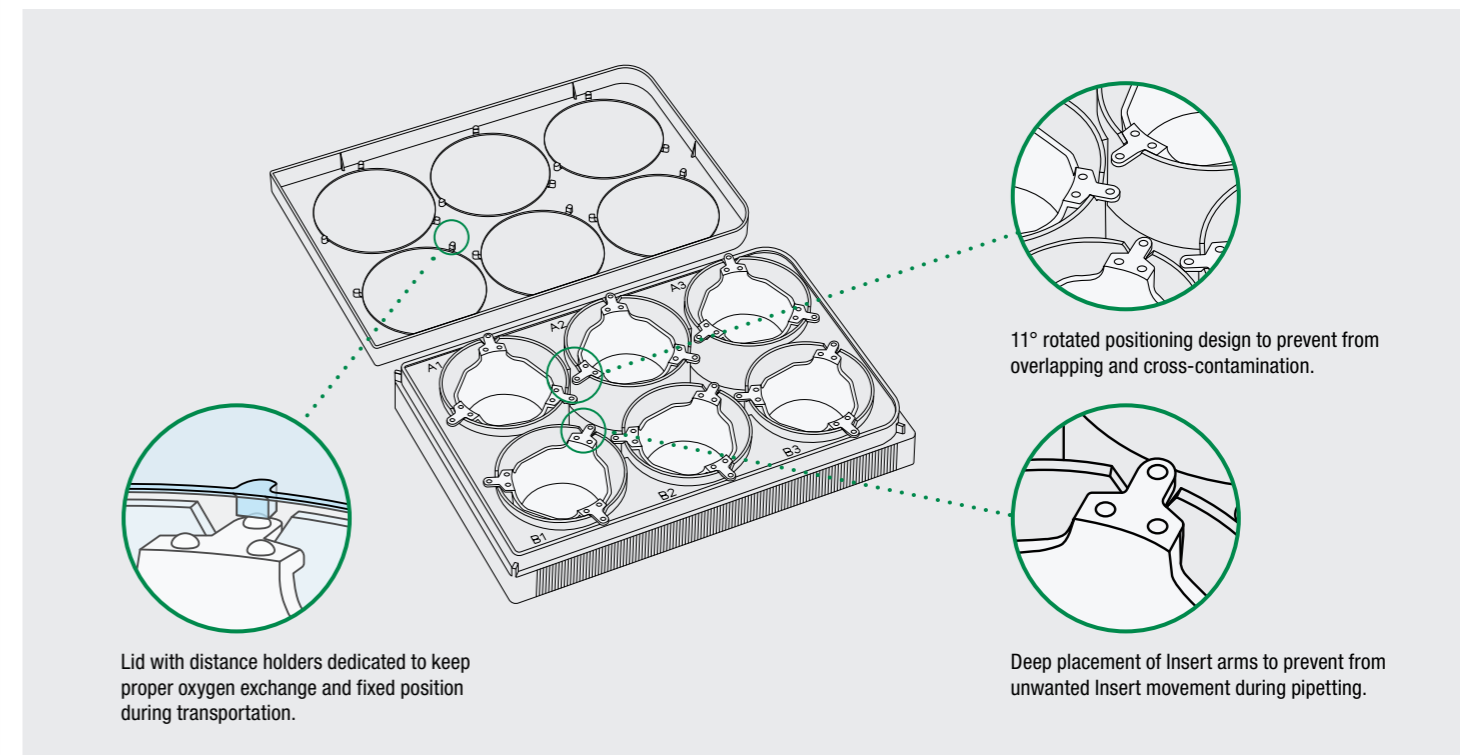

Product characteristics

Our cellQART® Cell Culture Inserts come with tissue culture treated PET (Polyester/Polyethylene Terephthalate) membranes, are gamma sterilized and are available in various optical versions:

Clear PET	Clear extended culture PET	Translucent PET
Clear PET membranes enable superior optical transparency for visualization of cells by using phase contrast/bright field microscopy.	Clear extended culture PET membranes have the optimal pore density to support long term cultures. These membranes allow for monitoring by using phase contrast/bright field microscopy.	Translucent PET membranes have a high pore density. This allows for maximum diffusion of materials between the Cell Culture Insert and receiver Plate.



Clear PET / Clear extended culture PET



Translucent PET

Our standard portfolio is compatible with most standard 6-, 12- and 24-Well Plates and has different pore sizes from 0.4 µm to 8.0 µm with various pore densities. Additionally cellQART® Cell Culture Inserts are available pre-loaded in our especially designed Well Plates. All Cell Culture Inserts are TC treated and gamma sterilized as well as RNase/DNase free and non-pyrogenic. With our industry leading quality standards we assure 100% membrane parameter consistency for reproducible cell culture results.



TC treated



Gamma sterilized



100% membrane parameter consistency

Materials	
Membrane component:	Polyester (PET)
Plastic component:	Polystyrene (PS)

Applications

Pore size recommendations

Our cellQART® Cell Culture Inserts are designed for use in various applications with different pore size requirements.

Application	Cell type	Pore size recommendation (µm)
Angiogenesis	Endothelial, HMVEC, HUVEC	3.0
Co-culture	Stem, neuronal and various others	0.4, 1.0
Epithelial cell polarity	Epithelial cells	0.4
Invasion	Melanoma	8.0
	Glioma	8.0
	Lymphoma, Jurkat	5.0, 8.0
	Osteoblasts	8.0
	Breast cancer	5.0, 8.0
	Endothelial	3.0, 5.0, 8.0
Migration	Endothelial, HUVEC, HMVEC	3.0
	Neutrophils, PMNs	3.0
	Lymphocytes, macrophages, monocytes	3.0, 5.0
	Neuronal cells	3.0
	Dendritic cells	3.0, 5.0, 8.0
	Neurite outgrowth	1.0, 3.0
	Epithelial fibroblasts	8.0
	Leukocytes	3.0, 5.0
	Smooth muscle	8.0
	Tissue engineering	Human skin model
Toxicity testing	Mouse fibroblasts	3.0
	Human lung	0.4
Transport and permeability studies	Caco-2, MDCK	0.4, 1.0

Product advisor

Visit our cellQART® webshop and let our product advisor help you find the best product for your application:

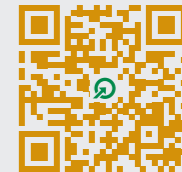

cellqart.com/product-advisor



Many applications:

- Tissue barrier models
- Drug transport studies
- Toxicity testing
- Cosmetic testing
- Air-Liquid Interface (ALI) cultures
- Direct and indirect co-cultures
- Migration assays
- Invasion assays

Visit our cellQART® Academy to stay up to date with our scientific presentations, publications and educational resources.

Read our application reports or find a list of papers citing cellQART®.

cellQART® Academy



cellqart.com/academy

Application reports

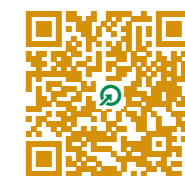

cellqart.com/academy/application-reports

Portfolio overview

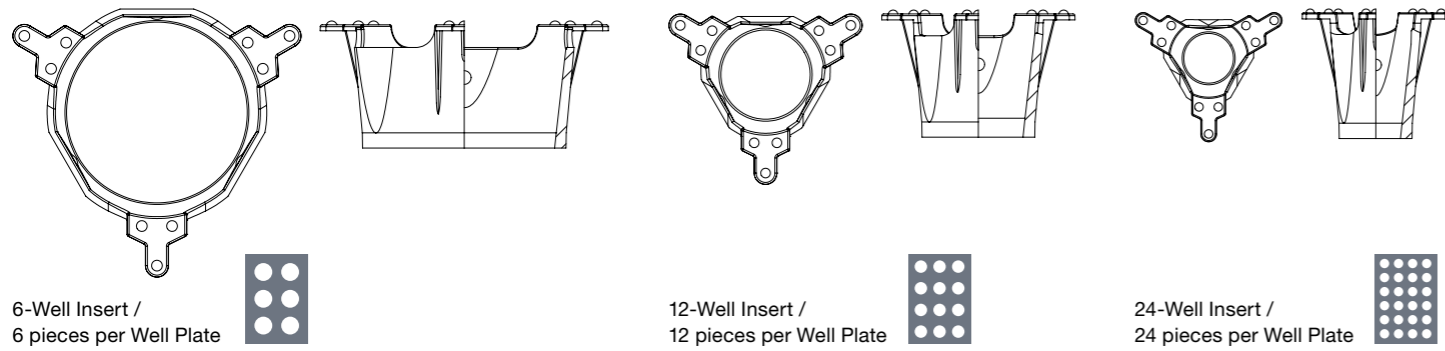

6-Well Insert /
6 pieces per Well Plate

12-Well Insert /
12 pieces per Well Plate

24-Well Insert /
24 pieces per Well Plate

1:1 original cellQART® Cell Culture Insert dimensions

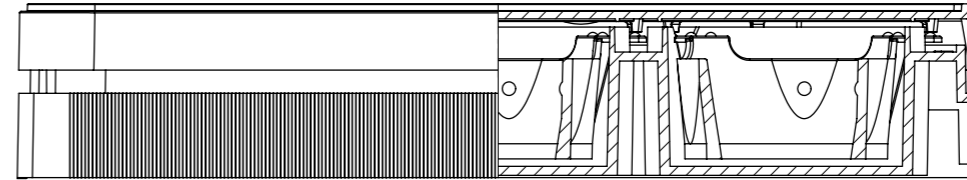
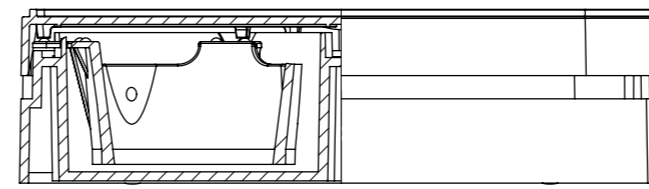

1:1 original cellQART® Well Plate dimensions

Portfolio – Single Inserts

	Picture	Growth area	Membrane optics	Pore size	Pore density per cm ²	Membrane thickness	Item number	Quantity per box
6-Well Insert PET		4.5 cm ²	○ Translucent	0.4 μm	100 × 10 ⁶	11.5 ± 2.0 μm	930 04 02	48 Inserts
				1.0 μm	2 × 10 ⁶	11.0 ± 2.0 μm	930 10 02	
				3.0 μm	2 × 10 ⁶	9.0 ± 2.0 μm	930 30 02	
				5.0 μm	0.6 × 10 ⁶	10.5 ± 2.5 μm	930 50 02	
				8.0 μm	0.2 × 10 ⁶	12.5 ± 3.0 μm	930 80 02	
		○ Clear extended culture	0.4 μm	4 × 10 ⁶	11.5 ± 2.0 μm	930 04 22		
			0.4 μm	2 × 10 ⁶	11.5 ± 2.0 μm	930 04 12		
		○ Clear	1.0 μm	2 × 10 ⁶	11.0 ± 2.0 μm	930 10 12		
			3.0 μm	0.6 × 10 ⁶	12.0 ± 2.0 μm	930 30 12		
			5.0 μm	0.6 × 10 ⁶	10.5 ± 2.5 μm	930 50 12		
			8.0 μm	0.1 × 10 ⁶	12.5 ± 3.0 μm	930 80 12		
			12-Well Insert PET		1.1 cm ²	○ Translucent	0.4 μm	
1.0 μm	2 × 10 ⁶	11.0 ± 2.0 μm					931 10 02	
3.0 μm	2 × 10 ⁶	9.0 ± 2.0 μm					931 30 02	
5.0 μm	0.6 × 10 ⁶	10.5 ± 2.5 μm					931 50 02	
8.0 μm	0.2 × 10 ⁶	12.5 ± 3.0 μm					931 80 02	
	○ Clear extended culture	0.4 μm		4 × 10 ⁶	11.5 ± 2.0 μm	931 04 22		
		0.4 μm		2 × 10 ⁶	11.5 ± 2.0 μm	931 04 12		
	○ Clear	1.0 μm		2 × 10 ⁶	11.0 ± 2.0 μm	931 10 12		
		3.0 μm		0.6 × 10 ⁶	12.0 ± 2.0 μm	931 30 12		
		5.0 μm		0.6 × 10 ⁶	10.5 ± 2.5 μm	931 50 12		
		8.0 μm		0.1 × 10 ⁶	12.5 ± 3.0 μm	931 80 12		
		24-Well Insert PET			0.3 cm ²	○ Translucent	0.4 μm	100 × 10 ⁶
1.0 μm	2 × 10 ⁶		11.0 ± 2.0 μm				932 10 02	
3.0 μm	2 × 10 ⁶		9.0 ± 2.0 μm				932 30 02	
5.0 μm	0.6 × 10 ⁶		10.5 ± 2.5 μm				932 50 02	
8.0 μm	0.2 × 10 ⁶		12.5 ± 3.0 μm				932 80 02	
	○ Clear extended culture		0.4 μm	4 × 10 ⁶	11.5 ± 2.0 μm	932 04 22		
			0.4 μm	2 × 10 ⁶	11.5 ± 2.0 μm	932 04 12		
	○ Clear		1.0 μm	2 × 10 ⁶	11.0 ± 2.0 μm	932 10 12		
			3.0 μm	0.6 × 10 ⁶	12.0 ± 2.0 μm	932 30 12		
			5.0 μm	0.6 × 10 ⁶	10.5 ± 2.5 μm	932 50 12		
			8.0 μm	0.1 × 10 ⁶	12.5 ± 3.0 μm	932 80 12		

Customizations (especially alternative membranes, e.g. further pore sizes) upon request.

Portfolio – Fully pre-loaded Well Plates (FP)

	Picture	Growth area per Insert	Quantity per Well Plate	Membrane optics	Pore size	Pore density per cm ²	Item number	Quantity per box
6-Well Plate		4.5 cm ²	6 Inserts	○ Translucent	0.4 μm	100 × 10 ⁶	930 04 04	4 Well Plates 6 Inserts per Well Plate
					1.0 μm	2 × 10 ⁶	930 10 04	
				○ Clear extended culture	0.4 μm	4 × 10 ⁶	930 04 24	
					0.4 μm	2 × 10 ⁶	930 04 14	
12-Well Plate		1.1 cm ²	12 Inserts	○ Translucent	0.4 μm	100 × 10 ⁶	931 04 04	4 Well Plates 12 Inserts per Well Plate
					1.0 μm	2 × 10 ⁶	931 10 04	
				○ Clear extended culture	0.4 μm	4 × 10 ⁶	931 04 24	
					0.4 μm	2 × 10 ⁶	931 04 14	
24-Well Plate		0.3 cm ²	24 Inserts	○ Translucent	0.4 μm	100 × 10 ⁶	932 04 04	4 Well Plates 24 Inserts per Well Plate
					1.0 μm	2 × 10 ⁶	932 10 04	
				○ Clear extended culture	0.4 μm	4 × 10 ⁶	932 04 24	
					0.4 μm	2 × 10 ⁶	932 04 14	
				○ Clear	1.0 μm	2 × 10 ⁶	932 10 14	

Customizations (especially alternative membranes, e.g. further pore sizes) upon request.

Portfolio – Half pre-loaded Well Plates (HP)

	Picture	Growth area per Insert	Quantity per Well Plate	Membrane optics	Pore size	Pore density per cm ²	Item number	Quantity per box
24-Well Plate		0.3 cm ²	12 Inserts	○ Translucent	0.4 μm	100 × 10 ⁶	932 04 06	4 Well Plates 12 Inserts per Well Plate
					1.0 μm	2 × 10 ⁶	932 10 06	
				○ Clear extended culture	0.4 μm	4 × 10 ⁶	932 04 26	
					0.4 μm	2 × 10 ⁶	932 04 16	
				○ Clear	1.0 μm	2 × 10 ⁶	932 10 16	

Customizations (especially alternative membranes, e.g. further pore sizes) upon request.

Portfolio – Empty Well Plates

	Picture	Item number	Picture	Item number	Picture	Item number	Quantity per box	
6-Well Plate		930 00 02	12-Well Plate		24-Well Plate		932 00 02	4 Well Plates

Innovative products

Portfolio – Flat Inserts (HP)

	Picture	Growth area per Insert	Quantity per Well Plate	Membrane optics	Pore size	Pore density per cm ²	Item number	Quantity per box
24-Well Plate		0.3 cm ²	12 Inserts	○ Translucent	0.4 μm	100 × 10 ⁶	932 04 061	4 Well Plates 12 Inserts per Well Plate
				● Clear extended culture		4 × 10 ⁶	932 04 261	

Customizations (especially alternative membranes, e.g. further pore sizes) upon request.



MYcellQART – Customized to unleash innovation

You might have thought about a better product to support your cell culture innovation roadmap already. Based on our experience with product development here is a selection of potential starting points / use cases for our first project:

- 🔄 2 hours workshop to translate application needs into commercial, technical and regulatory requirements.
- 🔄 Modification of an existing cell culture insert currently used in your lab (e.g. dimensional changes for optimized workflow and lower total cost).
- 🔄 Run a Design-of-Experiments with different membrane parameters to identify the best design fit for your application.
- 🔄 Manufacture prototypes based on already existing design.
- 🔄 Co-develop a breakthrough application from scratch (e.g. 96-Well high throughput format).
- 🔄 Design-for-Manufacturing optimization for an already designed product idea.
- 🔄 Large scale industrialization of high runner disposables.

Single source solutions

Project based customization possible due to 100 % in-house production of plastics & membrane components. We manufacture our products in clean room environment (ISO class 8). Our quality management system complies with ISO 9001 and ISO 13485.

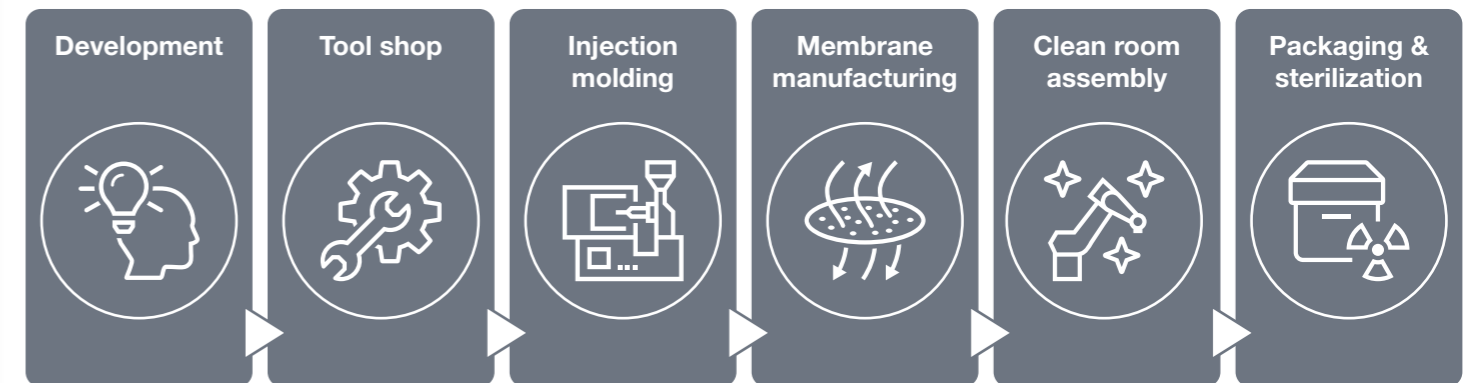

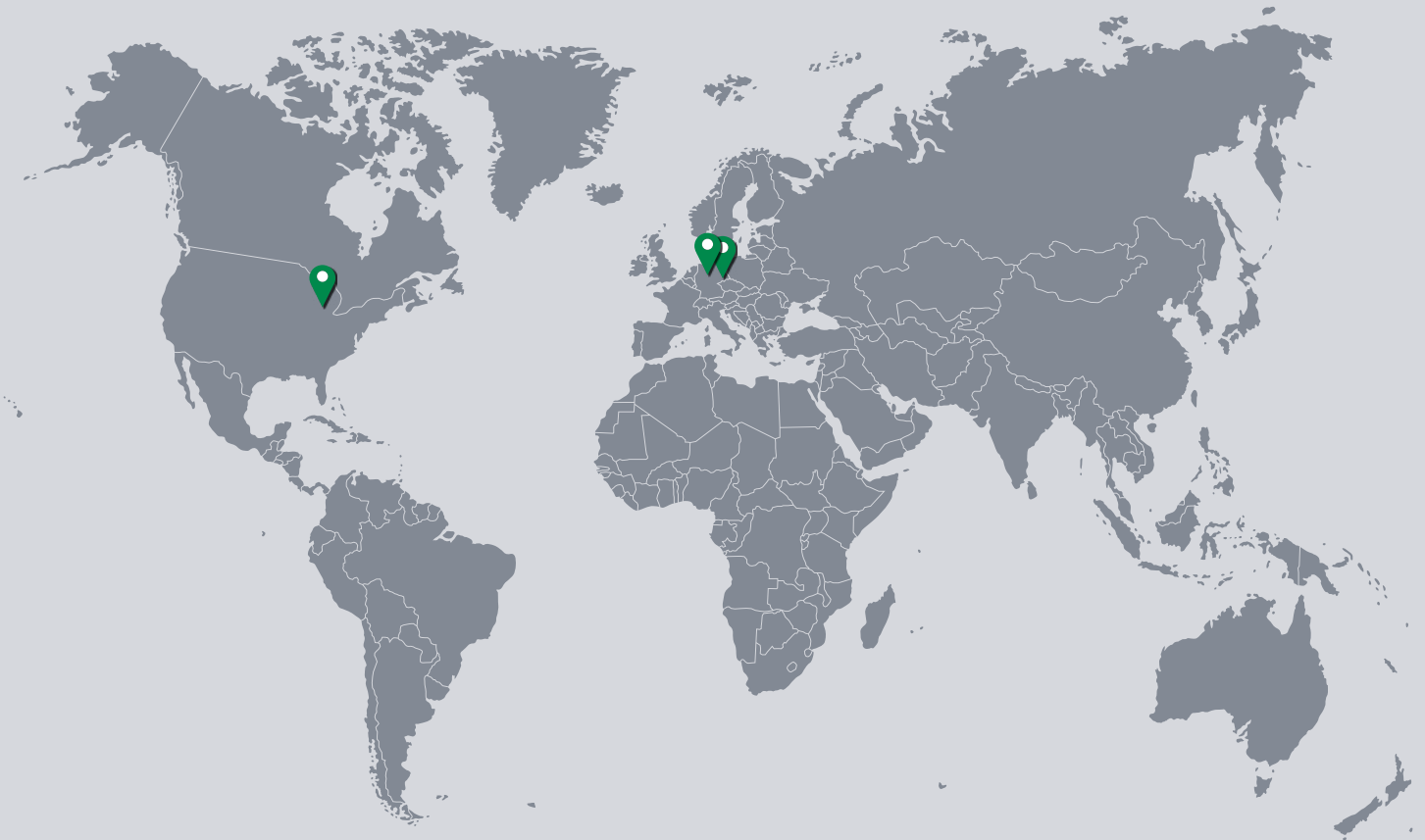

↓ Further product information:



MADE IN

GERMANY

Follow us on LinkedIn, X/Twitter or Instagram
and subscribe to our YouTube channel.



SABEU GmbH & Co. KG
Headquarters & Plastics Technology
37154 Northeim
Germany

SABEU GmbH & Co. KG
Membrane Center of Competence
01454 Radeberg
Germany

Altenloh, Brinck & Co. US Inc.
Sales Center North America
49503 Grand Rapids, Michigan
USA